



# Product Catalogue

## 2026

**Laboratory Equipment and  
Consumable Supplies**

Email: [info@jlwsupplies.co.za](mailto:info@jlwsupplies.co.za)  
Tel: 021 300 2156  
[www.jlwsupplies.co.za](http://www.jlwsupplies.co.za)

# INSTRUMENTATION



## Autoclaves

SANS 347 Approved  
Floor Standing , Benchtop and  
Horizontal available  
Range offered from 16 litre to  
4275 litre  
Pressure testing and AIA  
recertification available



## Bioreactor Systems

CELBIC – Single Use Cell  
Culture System: By using  
disposable cell culture bags, it  
can reduce the risk of  
contamination by 5-20% and  
even reduce initial investment  
costs, operating costs, and  
environmental pollution.



## Biosafety Cabinets

Various sizes and models  
available  
Class II Type A2/B2  
User protection against  
pathogens

## Balances

Micro, Analytical, Precision and Moisture Balances  
available

Internal/External calibration

Various display options from basic LED to touch screen

Various interfaces available USB and optional WIFI



# Animal Behaviour Systems - Noldus Information Technology

## DanioVision

A system for tracking zebrafish larvae and adult fish

Research Fields where it is used:

Neuroscience  
Pharmacology  
Toxicology  
Veterinary Science  
Entomology  
Ethology



## EthoVision XT

The most advanced tracking software with almost 30 year track record  
and constant evolution

## CatWalk XT

The ultimate tool for gait analysis

Various animal models from pain research to Parkinson's

Research area where it is used:

Spinal cord injuries  
Parkinson  
Allodynia  
Arthritis  
Peripheral Nerve injury  
Traumatic Brain Injury  
Huntington  
Amyotrophic Lateral Sclerosis



## PhenoTyper 2

The optimal environment for rodent behavioural research. It is an instrumented  
home cage for behavioural observation of rodents, which includes amongst many  
things, a camera, lighting feed, water and enrichment.





## Bottletop Dispensers

Cover full range of sizes from 1-100ml  
Max viscosity of 500mm<sup>2</sup>/s  
GL45 Bottle top attachment and adapters  
Fully Autoclavable at 121°C,



## Colony Counters

Benchtop colony counter  
Digital  
Magnification  
Audible counting



## Conductivity Meters

Available in both Bench top and Portable options  
Also available as multiparameter meters

## Centrifuges

Large variety: Refrigerated centrifuges, Clinical centrifuges, microcentrifuges and floor-standing  
Various Rotor options to choose from  
Adaptors to accommodate all tubes and vessels  
Floor standing mega centrifuges on request





## Dissolved Oxygen Meters

Available in both Bench top and Portable options  
Also available as multiparameter meters



## Dry Baths

Digital Display and timer  
Single block and dual block options  
Up to 120°C with overtemperature protection  
Blocks for tubes available from 0.2ml to 50ml  
Blocks for plates available 96 or 384 wells



## Dry Baths Advanced

Available as only Heating or Heating and cooling options  
Excellent accuracy  
Optional shaking mechanism to 1500 Rpm  
Over temperature protection  
0.5/1.5 or 2ml tubes

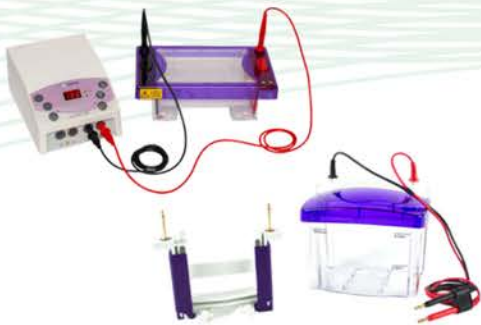

## Electrophoresis Systems

Available as horizontal or vertical gel systems  
Blotting Systems also available  
All sizes  
Compatible with power supplies of most brands



## Elisa Plate Washers

Various models to choose from to best suit your application  
All CE and FDA approved



## Elisa Readers

Various models to choose from to best suit your application  
All CE and FDA approved



## Environmental/ Climate Chambers

There are several types of climatic chambers, according to different requirements and to the type of test which must be carried out

Sizes varying from 25 Litre up to 2300 Litres application specific  
 Temperature between -40°C and 180°C application specific  
 Humidity from 0-98%  
 Lighting options available



## Freeze Dryers

Widely used in drugs, biological products, chemical and food industries

Condenser temperature of -60°C  
 Optional functions and accessories available



## Fume Hoods

Various sizes and models  
 Both ducted and non-ducted options  
 Polypropelene options available  
 Motorised sash window and all accessories included



## Furnaces

Tube Furnaces and Muffle Furnaces working at various temperatures and available in various sizes.



## Gel Documentation Systems

Numerous models to choose from  
 Economic to advanced systems available  
 Easy to operate and reliable results

## Gene Electroporator

Electroporation of bacteria, yeast, and other microorganisms.

- Transfection of mammalian cells, plant tissues, and protoplasts.
- Cell hybridization and gene fusion.
- Introduction of marker genes for labeling and indicating purposes.
- Introduction of drugs, proteins, antibodies, and other molecules for studying cellular structure and function.



## Gene Guns

Gene gun technology (particle bombardment) is a new gene introduction technique that accelerates micron-sized gold or tungsten particles encapsulated with nucleic acids to the desired speed to introduce genes into cells, tissues, organs and tissues. It can get instant stable and high efficient expression and transformation. It is fast, easy and safe. Available in Manual or High pressure gas gene gun

## Grinder/Lyser- High throughput (Bead-type)

The high-throughput tissue lyser is a new generation of fast, efficient and safe grinding system. It supports the extraction and purification of raw DNA, RNA and proteins from soil, plant and animal tissue, bacteria, yeast, fungi, spores, paleontological specimens etc.

Supports dry, wet and mixed grinding and homogenization. It can effectively improve the grinding efficiency and quality, reduce labour cost, reduce the error of manual operation, and at the same time can avoid the risk of using liquid nitrogen and other external freezing methods. SCIENTZ Bio has launched **12, 24, 48, 96 and 192 throughput** tissue mills, and for heat-sensitive samples, a **frozen high-throughput tissue mill** is also available



## Fridges & Freezers

A wide variety of fridges and freezers with various capacities to fit your application and lab space  
Excellent Temperature stability  
-40°C/-25°C and 2-10°C available  
Small under bench to triple door units to choose from



## Freezers Ultra Low

-86 Ultralow Freezers in variety of sizes  
58L up to 838L units  
Upright and Chest Freezer type





## Homogenizers/ MultiTube Homogenizers

Analogue 6 up to 10 speed options available to cover 8000 to 40000 RPM

Volumes from 0.1m up to 5000ml can be covered depending on model

For use on Solids / Liquids / oils

Max viscosity 10000mPa

**SPECIAL MULTI TUBE  
OPTIONS AVAILABLE**



## Mini Homogenizer

Handheld battery operated

Plastic disposable or stainless steel pestles

Ideal for eppies and small tubes



## Hotplate Stirrers

Various sizes according to your specific lab requirements

Single or multiple position options available

Digital

Up to 550°C

Include Temp Probe



## Ice Makers

Available in variety of sizes

Flakers or cube type



## Incubator Shaking

Large variety

Bench top to multi layer

Heating and cooling



## Incubator - Constant Temperature

Various size options available

Glass inner doors

Large temperature range can be covered from 0 °C to 70°C

depending on requirements

Digital

Excellent temperature stability



## Incubators CO<sub>2</sub>

Various Models and Sizes  
Water and Air Jacketed options available  
Sterilization options available

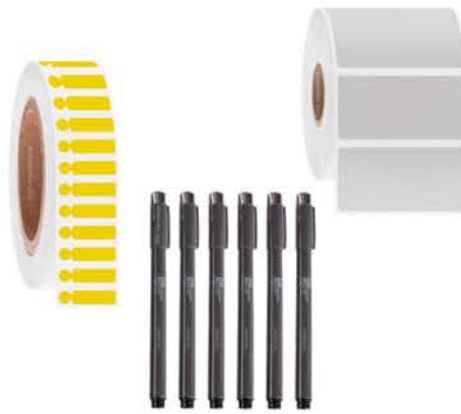

## Labels & Labelling Solutions

Full range of laboratory labels designed and patented by GA-Labtag International  
Cryo labels/ Chemical Resistant labels / Autoclave labels  
Also available printer and lab software



## Laboratory Glassware Washers

Various sizes from underbench to double volume  
Racks and accessories for all your glassware requirements  
Optional drying functions



## Laminar Flows

Various size options available  
Vertical or Horizontal flow  
For protection of samples against contamination



## Loop Steriliser

Electronic infrared loop sterilizer for safe sterilization on the benchtop  
Temperature of 830°C  
Ceramic Heating tube 140mm long



## Luminometer

Lumi – Single Tube Luminometer is a small luminescence measurement device with a small and compact design. It is a product that can measure light from chemiluminescence reaction more conveniently and more accurately using PMT procedure through a 7.0" touch LCD screen. .  
Data can also be easily backed up via USB.



## Magnetic Stirrers

Various sizes according to your specific lab requirements  
Single or multiple position options available  
Analogue or digital



## Micro Volume Spectrophotometers

Minimum sample volume 1µl  
Cuvette and microvolume sample  
Measurement of single wavelength as well as spectrum analysis using spectrometer technology  
Simple and miniature design  
Stand-alone system with easy-to-use 7.0" LCD touch screen  
Simple data backup using USB  
Modes: DNA/RNA, protein, cells, end point, kinetic, spectrum



## Micropipettes

Single and multi-channel manual adjustable pipettes  
All universal tips fit the pipettes  
Fully autoclaveable at 121°C  
Carroussel or linear stands available



## Microscopes

Compound / Stereo/Inverted  
Routine And Research  
Microscopes  
Microscopes used in Pathology and Routine Diagnostic work  
With or Without camera  
With or Without Fluorescence



## Microtitre Mixer

Analogue Speed Control  
Orbital shaking 0-1500 RPM  
Wide range of optional Accessories



## Moisture Analyzer/Balance

Various Models  
LCD and Touch options  
Heating 40°C to 199°C  
RS232 /USB Interface



## Microbial Growth Curve Analyzers

**MGC Series Microbial Growth Curve Analyzer** covers the differentiated cultivation needs of different microorganisms, whether they are oxygen-dependent aerobic bacteria, micro aerobic bacteria that prefer low oxygen environment, or even oxygen-sensitive strict anaerobic bacteria, all of them can realize their growth and proliferation under the appropriate cultivation environment.

It is a **fully automated instrument**, which can realize real-time detection of microbial growth under different culture temperatures, different gas environments, different shaking conditions and different light combinations, and automatically draw growth curves, providing a powerful aid for microbial research such as fine-tuning of cultivation conditions, exploring the performance of different strains, and evaluating the sensitivity of antibiotics.

Moreover, the whole process of testing does not need to be guarded, no need to take samples frequently, completely eliminating the risk of contamination, saving time and labour.

### Featured functions:

- Air Control System
- High Speed Vibration
- Full Spectrum Scanning
- Long Life Xenon Lights Lighting function
- High Precision Temperature control
- Simple and Easy to use



## Ovens - Drying

Various Models  
Convection, Fan options and  
Vacuum ovens  
Temperature ranges up to  
400°C



## Overhead Stirrers

20litre and 40 Litre options  
Speed range :50-2200 RPM  
Comes Standard with Universal  
Plate Stand and Cross Stirrer

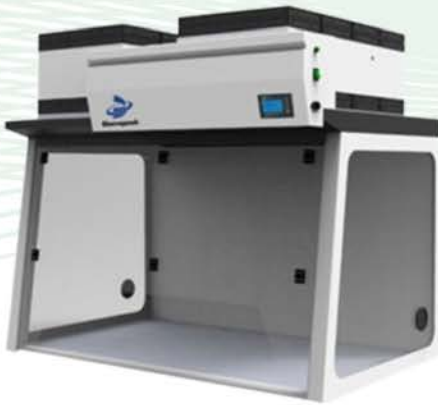

## PCR Hoods

Dead box or HEPA filtered  
options  
Benchtop or stand options  
UV sterilization



## Peristaltic Pumps

Various models and heads to  
select from  
Flow rates from 0.007 ml/min up  
to 2280ml/min  
Accessories available



## pH Meters

Benchtop and portable pH meters as well as other chemistry meters are available  
Electrodes to suite various applications  
Buffers for calibration



## Plate Reader - Byonoy

World's smallest 96 well plate reader

Free software

Absorbance method with endpoint and Kinetic detection modes

Evaluation modes :Quantitative, Qualitative

Regression Methods Point-to-Point, linear , 4PL and 5PL

Now also in automated version



## Pro Pipette Fillers

Electronically controlled pipette filler  
Works with Glass and Plastic pipettes 0.1 – 100ml  
Max aspirate speed 25ml/s  
LCD display  
Low Battery indicator  
Adapter is fully autoclaveable  
Includes 2 filters, Battery charger and docking station as standard accessories



## Rotary Evaporators

Vertical or Diagonal unit with autolift  
Baths available in 5 liter or 10 liter  
Comes standard with Glassware set



## Scale

We offer a full range of scales  
Platform , Precision , Benchtop  
and floor standing options



## Shakers

Orbital, linear and rocking  
shakers with accessories  
Analogue and digital options  
Speed range of up to 500Rpm –  
model dependant  
Weight of up to 10Kg – model  
dependant



## Slide Dryers

Various models available  
Flat or angled options



## Sonicator - Ultrasonic Homogenizer

Large TFT screen Display, Touch  
control  
Login Password Protection  
System for data security  
Various probe sizes available  
The ultrasonic power can be  
adjusted continuously  
The program has over-  
temperature/delay/fault protection  
alarm  
Sound-proof Chamber included

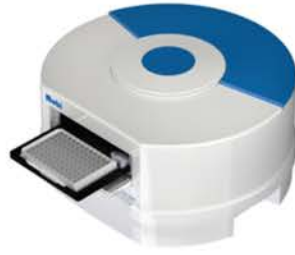

## Spectrophotometers

Visible and UV Spectrophotometers  
for 10mm Cuvettes  
Wavelength from 200 – 100nm –  
model dependant  
LCD Display  
Single beam / Double Beam and  
Microplate units

## Stomacher Homogenizer



FDA

3-400ml Samples capacity  
Sturdy and reliable  
Paddle Blending action  
Work with any stomacher bags



## Syringe Pumps

Various models to  
accommodate variety of  
syringes  
Large selection volumes

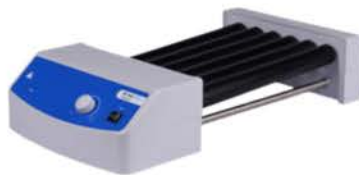

## Tube Rollers

6 Rollers  
Analogue or Digital  
Adjustable speed up to 70RPM  
Continuous or timed



## Thermometers

Various temperature range options  
Waterproof models available  
Infrared, large display, probe and  
pocket types



## Ultrasonic Cleaners

Various Sizes 3 litres up to 27 litres  
Heating and Auto-Degas function  
Accessories includes



## Ultrasonic DNA Shearing (Non-Contact)

The ultrasonic DNA shearing instrument uses an isothermal and non-contact method to shear, homogenize and mix samples. The maximum processing capacity at one time is 18 samples, and the minimum volume is 5  $\mu$ l. For laboratories that need to process multiple samples or precious samples every day, it has the advantages of high processing throughput, low sample loss, and no cross-contamination. It has gradually become an indispensable standardized tool for ChIP (Chromatin Immunoprecipitation) and DNA shearing research platforms



## Vacuum Pumps

Diaphragm and oil pumps available  
Various options for specific applications

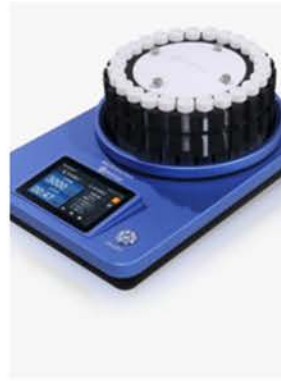

## Vortex Mixers

Vortex Mixer with attachments available as single vortex or multiple tube vortex  
Analog and Digital options  
Continuous/Touch Operation  
Speed range from 0-3000 Rpm depending on model  
Various optional adapters



## Water Baths (Traditional & Cooling)

Various sizes available  
Heated and cooled options  
Unstirred, circulated or shaker options  
Thermostatic water baths ranging from -80 °C to +220°C  
Perfect temperature control



## Water Purifiers

Laboratory water purification systems for Type I and Type II water production  
Various modes and sizes  
Media preparation to Ultrapure available  
Affordable filters  
Made by Boeco Germany

# CULTURE MEDIA



## We are proud suppliers of Biolab culture media!

Biolab offers guaranteed high-quality products at an affordable price. Their product range includes culture media, supplements and antimicrobial susceptibility discs manufactured under the ISO 9001-2000 quality assurance system.

They are the biggest Hungarian supplier for microbiological laboratories in health care, food and water microbiology, mineral water and soft drinks, university and scientific research, and veterinary and pharmaceutical industries.



**biolab**  
FOR SPLENDID ISOLATION

# BLOOD COLLECTION CONSUMABLES



## Blood Collection Tubes

Available with a variety of additives to suit almost any application  
Various size options



## Erythrocyte Sedimentation Rate Test (ESR)

Completely closed system to help protect laboratory personnel from the risks associated with blood handling  
2-part system features a Westergren Pipette and Reservoir Tube  
Westergren pipette is composed of crystal polystyrene, 220mm long and 1mm increments over 150mm length and upper end has a polyethylene stoppered valve  
Polypropylene Reservoir Tube consists of an upper pierceable stopper and thin diaphragm inserted into a clear lower vial containing sodium citrate anticoagulant



## Sample Needles & Accessories

Sterile, pyrogen free, non-toxic  
Multi-sample, blood collection and safety blood collection needles  
Available in a variety of gauges  
Tube holders (Bulldogs) available



## Lancets

Auto safety lancets and traditional twist off tip lancets available



## Tourniquets

Secure elastic tourniquet with clip for reliable blood flow control



## Sharps Containers

Transparent cap for content visualization  
FDA (USA) approved  
Made of tough, puncture resistant polypropylene  
Safe to incinerate and environmentally friendly  
Cap locks to base  
Maximum fill line  
Wide top aperture with integrated needle extractor  
Sizes ranging from 500ml to 13litre

# FILTRATION CONSUMABLES



## Benchkotes

Absorbent, impermeable material designed to protect laboratory surfaces against hazardous spills  
Available as sheets or rolls



## Filter Paper

Full line of high quality laboratory filtration papers including qualitative and quantitative filter papers, glass fiber and membrane filters for extraction thimbles and a variety of specialized applications



## Blotting Paper

Applicable to various blotting techniques  
Tested to ensure high and uniform capillary actions  
High wet strength for safe handling



## Pleated Filters

Filters for applications in reverse osmosis and water distilling systems



## Syringe Filters

Nylon, CA, PTFE, PVDF, MCE and PES options  
Range of pore and diameter sizes available  
Offered as sterile or non-sterile

# GLASSWARE



## Laboratory Glassware

Full range of glassware for liquid handling including beakers, cylinders, flasks, burettes, test tubes, funnels and more  
Various size options



## McCartney Bottles

Made of borosilicate glass  
Aluminum or plastic screw caps available  
Narrow, clear and wide mouth bottles available  
Numerous size options



## Media (Schott) Bottles

Clear and amber available  
Autoclavable Polyethylene screw cap and pouring ring  
Bottles are manufactured with Boro 3.3  
Clear white graduation marks and large marking area  
Various size options



## Pasteur Pipettes

Available plugged and unplugged  
Various size options



## Polytop Vials

Supplied with push-in stopper  
Various size options



## Slides & Coverslips

Slides available as single or double frosted; ground, cut or beveled edge; or clipped corners  
Coverslips available in a variety of sizes



## Thermometers

Various temperature ranges available

# GLASSWARE



## Capillary Tubes

ISO9001 compliant  
Heparinized and non-heparinized options available



## FluoroDish

Optical quality glass bottom for better imaging quality  
Low sample volume for expensive chemicals  
Lowest access angle for micropipette  
Low toxicity adhesive for embryo research



## HPLC/GC Vials

Variety of sizes and cap options to suite any application  
Micro inserts available

## Milk Analysis

As proud distributors of Funke Gerber, we offer an extensive range of milk analysis glassware, including butyrometers, hydrometers, milk pipettes and more



**FUNKE  
GERBER**

# HARDWARE



## Eye Wash Stations

Wall mountable, plastic and metal case options  
Variety of stations to choose from



## Labware Brushes

Nylon and bristle options available  
Brushes for a variety of applications, available in various sizes



## Spatulas & Forceps

Wide range of stainless steel spatulas and forceps available for a variety of applications



## Magnetic Stirrer Bars

Range of size options available



## Swabs

Plastic or wooden shaft  
Individually wrapped or bulk  
Variety of transport media



## Scalpels & Blades

Sterile disposable blades and scalpel handles  
Various blade sizes available

# HARDWARE



## Urine Test Strips & Rapid Tests

Rapid tests for a variety of applications  
Urine test strips - 10 parameter



## Weigh Boats

Antistatic weigh boats available in varying shapes and sizes



## Autoclave Tape

Available in 12mm, 18mm and 24mm rolls of 50m



## Cryoboxes

Cardboard and plastic options  
Available with or without grid  
81 or 100 place



## TLC Plates

Aluminum foil backed high-purity thin-layer chromatography silica gel powder as adsorbent  
20x20cm



## Cotton Wool & Paper Towels

Absorbent and non-absorbent cotton wool  
Soft and absorbent paper towel rolls - 210mm x 1000m

# MOLECULAR PLASTICS



## Cell Culture Plates, Flasks & Dishes

6-96 well cell culture plates  
T25, T75, T175 cell culture flasks  
available with vented or sealed cap  
35 and 60mm cell culture dishes



## Cryovials

Internal or external thread  
2ml and 5ml available



## Cell Scrapers

Sterile Individually wrapped  
13 x 250mm cell scraper,  
natural color, EO sterilization  
20 x 300mm cell scraper,  
natural color, EO sterilization

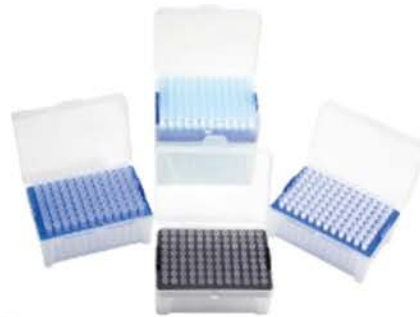

## Filter Tips

Racked and sterile filter tips available  
in 10-1250ul  
\*Unfiltered racked tips also available



## Serological Pipettes

RNAse, DNAse free  
Available in 1-50ml



## RNase/DNase Free Tubes

Sizes up to 50ml  
Snap-on and screw cap  
tubes available



## PCR Consumables

RNAse/DNase free half skirted  
PCR plates, 8-strip tubes with  
flat cap and PCR tubes  
PCR sealing film

# PLASTIC CONSUMABLES



## Autoclave Bags

Clear and red options  
Various sizes available



## Biohazard Specimen Bags

Sturdy to ensure safe disposal of biohazardous and infectious waste  
Various sizes available



## Microplates

Individually wrapped  
Sterile  
U-bottom and flat bottom available



## Pasteur Pipettes

Graduated  
Sterile individually wrapped and bulk options  
Various sizes available



## Petri Dishes

Sterile  
65mm and 90mm options



## Racks & Boxes

Tip boxes and tube racks available in various sizes and colours to suit any application

# PLASTIC CONSUMABLES



## Slide Storage Boxes

50 and 100 place options  
Various colours available  
with metal or plastic clip



## Specimen Containers

Polypropylene or polystyrene  
Labeled options  
Various sizes and cap colours  
available



## Syringes

Non-toxic, non-pyrogenic, latex-free, hypo-allergenic  
Luer slip and luer lock available  
Sizes ranging from 1ml - 50ml



## Pipette Tips

Universal fit tips  
Sizes ranging from 10ul to 10ml



## Centrifuge Tubes

Sizes ranging from 0.2 - 50ml  
Self standing tubes available in 50ml  
Screw and snap-on cap options



## Wash Bottles

Red and white cap options  
Durable polyethylene material

# GLOVES

## Nitrile Gloves

- Three times the puncture resistance of latex and offers excellent protection
- Superior dexterity, especially helpful with fine delicate work
- waterproof, greaseproof and oil proof
- Full finger textured and palm textured for optimum grip and use of intricate tools
- Contain no latex proteins or accelerators
- \*Colour options available on request



## Latex Gloves



- Sensitivity to touch
- Superior dexterity, especially helpful with fine delicate work
- Ambidextrous
- Effective protection in high-risk scenarios.
- Powder-free
- Biodegradable
- Conforms to international standards
- Supplied as non-sterile, include a beaded cuff design, and textured easy-grip surface.

### Why Golden Hands range of disposable gloves



For 15 years, Golden Hands has proudly reigned as South Africa's top gloves brand



Offering unbeatable value for money



Our gloves provide exceptional quality and durability without compromising affordability



Join the countless satisfied customers who have trusted Golden Hands for the perfect balance of value and performance



**Email: [info@jlwsupplies.co.za](mailto:info@jlwsupplies.co.za)**  
**Tel: 021 300 2156**  
**[www.jlwsupplies.co.za](http://www.jlwsupplies.co.za)**